



ROYAL

LOW RESONANCE ULTRA-COMPACT LOUDSPEAKER SYSTEM

Electro-Voice[®]

400

- SPECIFICATIONS
- INSTRUCTIONS
- APPLICATIONS

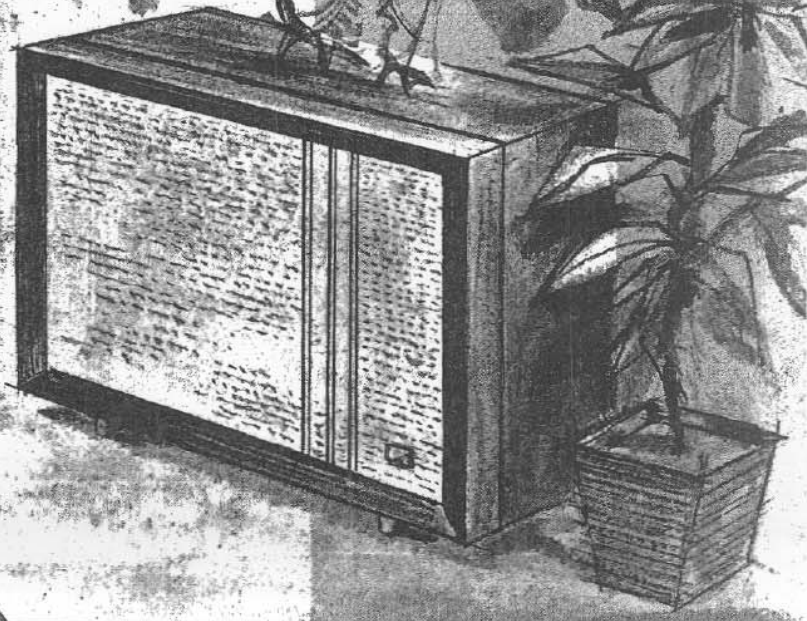
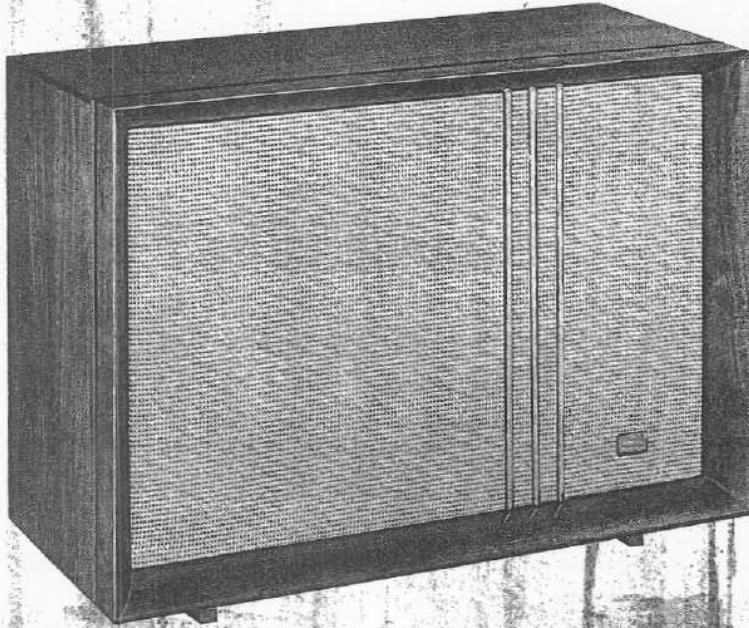

Electro-Voice®

ROYAL 400

INTRODUCTION

The new Electro-Voice Royal 400 is a 3-way low-resonance system which, despite its ultra-compact design, provides exceptionally wide-range response. It contains a special 18" woofer, the Electro-Voice Model 18WS, utilizing a 4 lb., 10 oz. ceramic magnet; an 8" mid-range cone-type speaker, with a 1 lb., 6 oz. ceramic magnet; and a compression-type very high frequency driver. These features make it an excellent choice for either monaural or stereo reproduction. Constructed of fine hardwood veneers, the use of heavy, vibration-free $\frac{3}{4}$ " panels gives the Royal 400 unusual rigidity.

SPECIFICATIONS

Nominal Impedance: 8 ohms

Power Handling Capacity:

Sine Wave: 30-2500 cps., 30 Watts, Maximum; 2500-20,000 cps., 5 Watts, Maximum.

Program: Maximum undistorted output of 70 Watts amplifier on complex program signal.

Frequency Response Range: 30-19,000 cps. \pm 4 db.

Components: 18" woofer, 8" extended range speaker, compression high-frequency driver, crossover network, two level controls.

Size: 15" Deep, 27 $\frac{3}{4}$ " High, 25 $\frac{1}{4}$ " Wide.

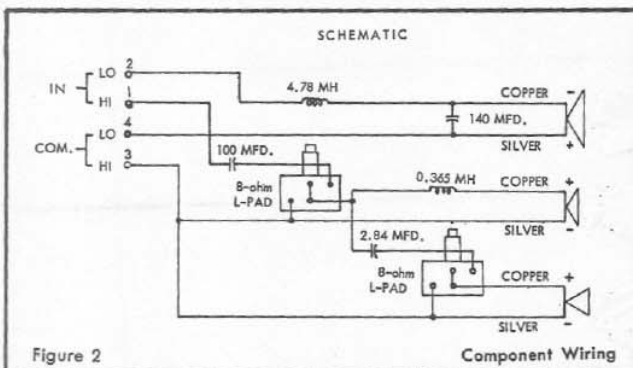

Figure 2

Component Wiring

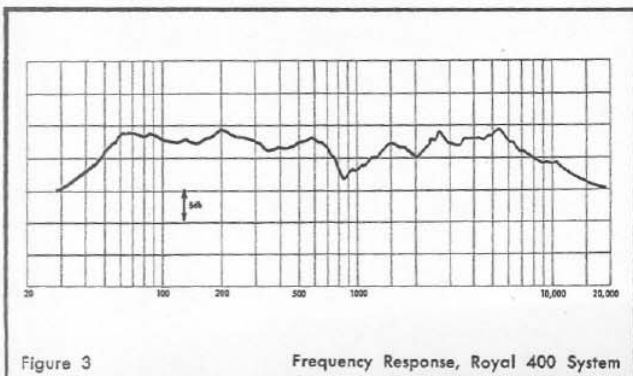

Figure 3

Frequency Response, Royal 400 System

Setting Up For Operation

Shipping Damage: Your Royal 400 is packed in accordance with all shipping requirements of the Interstate Commerce Commission, plus extra protection. If shipping damage occurs, contact the carrier directly, requesting inspection and instructions. Use the date code of the speaker in your correspondence.

Date Code Number: The date code is noted on your warranty registration card. The number indicates type, style, and date of manufacture of the unit. Always use this number in your correspondence.

Warranty Card: To register your Royal 400, fill out the Warranty Registration Card and send it to the factory within ten days after your purchase.

Placement

Any speaker system will sound best if it is placed in or near the corner of the room in which it is to be used. This positioning provides the best coupling between the speakers and the air in the room, the corners and walls acting as a large "horn" for the sound.

Connections

Connection of your Royal 400 to the amplifier should be made with No. 18 or larger wire (Common lamp cord is good). If you wish to run the lead between amplifier and speaker farther than 30' or to run it behind a moulding strip or under a carpet, use 300-ohm TV twin lead. Connect to the 8-ohm and common taps on the back of the amplifier. Be certain that these connections are secure. Connectors, already in place between terminals on the Royal (Fig. 4), should be left in place unless unit is used for stereo reproduction with E-V Stereon 300 "add-on" unit. Specific instructions will be found with the Stereon 300.

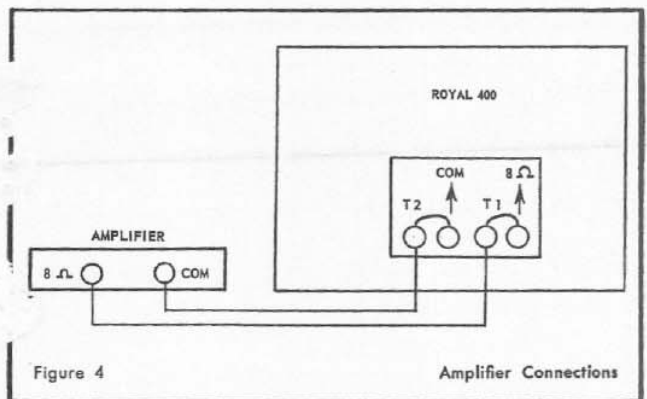

Figure 4

Amplifier Connections

Level Controls

Your Royal 400 is equipped with two controls, a treble array adjustment and a brilliance control, both of which are on the rear panel. Set treble array fully clockwise unless the unit is to be matched in a stereo arrangement with a speaker of differing efficiency.

Brilliance control setting should usually be at "NORMAL" but this may be adjusted to suit the acoustics of the room in which the Royal is used. A simple, convenient way to adjust the high-frequency level control is to tune in a live FM broadcast and listen closely to the announcer's voice, particularly the "s" and "t" sounds, at a volume level equal to that of your own speaking voice. Adjust the control until the "s"

and "t" sounds are no more prominent in the announcer's speech than they are in yours; such an adjustment will generally be quite satisfactory. Too high a setting of the high-frequency control will be audible as a piercing, harsh "metallic" sound. The best guide, of course, to proper setting of the control on the speaker system, is a familiarity with the sound of live music. Most listeners will find it easy to balance the sound to conform to their personal tastes.

Stereo Operation

Your Royal 400 is designed to give professional quality sound reproduction. The same performance features which make this unit outstanding for monaural reproduction will also give superb performance in stereophonic array.

The wiring connections for a pair of Royals in stereo are shown in Fig. 5. When connecting be sure to run the lead from T1 on the Royal to the 8-ohm terminal on the amplifier and from T2 to the COMMON terminal. With this connection both units will then be phased correctly.

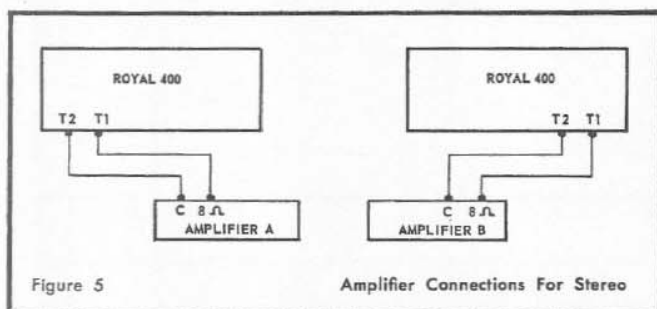

Placement For Stereo

When arranging a pair of Royal 400's in stereo array, the units should be placed at positions which allow the listener to sit in the area of the apex of a 30° to 40° angle, as shown in Fig. 6. This will provide the best stereophonic effect. If this placement is not possible, you may, by experiment, use room reverberations to advantage in finding other desirable positions.

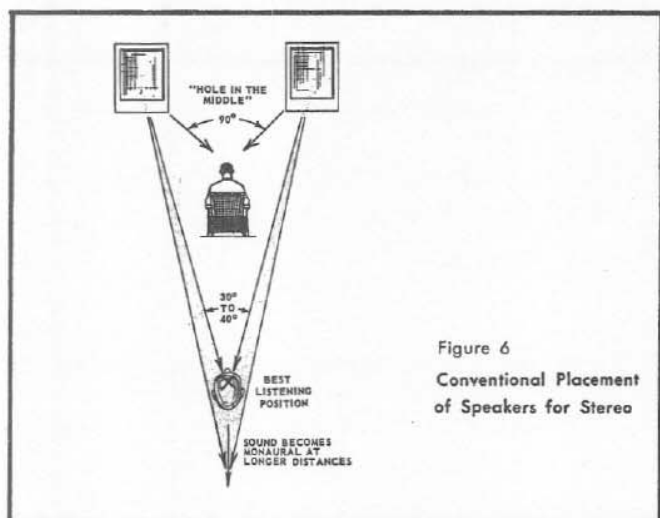

Widening The Stereo Area — 3-Channel Listening

The natural extension of 2-channel stereo reproduction is to

In stereo recording, great pains are taken to capture full realism by using 3 microphones to insure complete coverage of the sound stage. The sound from the microphone in the center is then "mixed out" to both left and right channels of recorded sound. From this master recording emerges the commercially available 2-channel stereo tape or disc.

In these "two track" stereo tapes and discs the element of this third channel remains and can be reformed by means of the Electro-Voice XT-1 Stereo Mixer Transformer. XT-1 recovers the center sound from the left and right channels, adds them together in the correct proportions, and passes them to the central speaker.

The addition of this third channel to your system gives complete flexibility of seating, in that one can now enjoy good stereo anywhere in a very large room, or more importantly, quite close to the loudspeakers in small rooms. At all times, in virtually any listening position there is a complete curtain of stereo sound.

Stereons

For those who have space or budget limitations, a Stereon 300 (see next page) can be used with the Royal 400 for either two- or three-channel stereo. The Stereon 300, which matches exactly the treble array of the Royal 400, can be used virtually without compromise in sound by taking advantage of a natural phenomenon: in 1934, an acoustic engineer, Harvey Fletcher, determined that sounds from about 300 cycles per second downwards in the audio spectrum (which have a wavelength greater than 3½ feet) are not intercepted to any perceptible degree by the head; accordingly, the ears find it impossible to detect the direction from which such sounds originate. E-V Stereons take advantage of this phenomenon by using the full bass reproduction capabilities of one full-range reproducing system for all bass and channelling the "stereo" sounds (above 200 cps.) correctly to each channel. The Stereons, then, permit easy and economical expansion to the stereo system.

The popular approach to E-V Panasound (3-channel stereo sound) is obtained by using two Royal 400's with one Stereon 300. This arrangement permits the use of two full-range units, to achieve the fullest bass response. Where space is an intense problem, good performance can also be achieved by using a pair of Stereon 300's with one Royal 400.

Complete wiring diagrams for connecting the Royal 400 with Stereons and XT-1 will be found in the instruction sheets accompanying the Stereon.

Speaker Repairs

Your Royal 400 system is guaranteed indefinitely against defects in workmanship and materials. Should it become damaged or develop faulty operation from unusual conditions of use, Electro-Voice maintains a complete service department to put equipment in factory-new conditions. Please write for authorization and shipping instructions before returning any equipment. Be sure to give full name and address together with a short description of the difficulties in your system.

Technical Service

The firm from which you purchased your equipment knows thoroughly the application of Electro-Voice products and high-fidelity stereo techniques. His advice on the installation of Electro-Voice components and on the selection of associated high-fidelity equipment will be invaluable. Technical problems which cannot be answered locally may be referred to:

MANAGER, CONSUMER PRODUCTS DIVISION
Electro-Voice, Inc.
Buchanan, Michigan

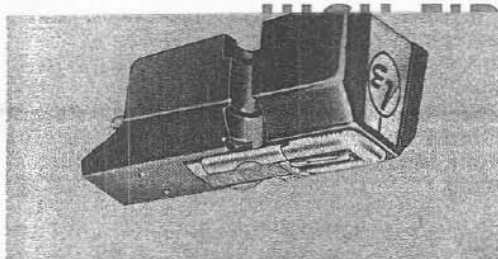

... **Uses Stereo Cartridge Using Ceramic Elements:** Electro-Voice is genuinely convinced that a precision ceramic cartridge is the finest type that can be made today . . . the superiority of the E-V Ceramic, Magneramic 31, is demonstrated in these three areas:

(1) *Greater Flexibility* — The 31 Series cartridge will operate perfectly at any stylus pressure from 2 to 20 grams. The same stylus assembly can be used for operation of both turntable and record changers; performance need not be compromised by using a special, stiff stylus assembly for record changers. Record wear is the only criterion in setting stylus pressure — cartridge operation is not affected. Thus, when converting from a changer to a turntable, or vice versa, replacement of the stylus assembly is not necessary when using the Magneramic 31.

(2) *Higher Output* — Along with the trend toward less efficient speaker systems, more amplifier power has become a necessity. While most stereo amplifiers are now designed with input sensitivities to match the typical 5 millivolt output of magnetic stereo cartridges, nearly all monaural amplifiers were designed for at least 8 millivolt input. These cannot be driven to full output with a magnetic stereo cartridge.

The Magneramic 31 develops a full 8 millivolt output and couples directly into any magnetic preamp unit. This higher output should be given special consideration by those planning to convert to stereo with existent monaural amplifiers.

(3) *Freedom from Hum.* — The increased amplifier gain required to drive low efficiency speakers coupled with decreased cartridge output has significantly increased system hum problems. Also, conventional methods of hum elimination used in monaural magnetic cartridges become difficult or impossible to apply to stereo magnetics. The Magneramic 31 completely eliminates these problems. It is non-inductive and has adequate output.

The Electro-Voice Magneramic 31MD7 cartridge directly replaces any monophonic or stereophonic magnetic cartridge now on the market. It feeds into the preamp input jack specified for magnetic cartridges and does not require adapter or circuit modifications.

SPECIFICATIONS — MAGNERAMIC 31MD7

<i>Response Range:</i>	20 to 15000 cps. + 2 db (Westrex 1A)	<i>Output:</i>	8 millivolts
<i>Compliance, Vertical:</i>	3.5×10^6 cm/dyne	<i>Recommended Load:</i>	22,000 to 47,000 ohms (Magnetic phono inputs)
<i>Compliance, Lateral:</i>	3.5×10^6 cm/dyne	<i>Elements:</i>	2, lead Zirconium Titanate (Ceramic)
<i>Isolation:</i>	28 db @ 1000 cycles	<i>Weight:</i>	8 grams
<i>Tracking Force:</i>	2 to 4 grams in transcription arms 4 to 6 grams in changer arms	<i>Terminals:</i>	4, standard .050" connectors
<i>Styli:</i>	.7 mil diamond	<i>Mounting Centers:</i>	Fits both 1/2" and 7/16"

Audiophile Net \$24.00

Want more information? Send for the booklet, "FACTS ABOUT THE ELECTRO-VOICE Magneramic Cartridge."

Model XT-1 Stereo Mixer Transformer



For use with the Stereon 300 and Royal 400. Only one required for two- or three-channel stereo system.

Audiophile Net \$13.50



Stereon 300

A two-way system consisting of a Radax extended-range speaker, together with a diffraction horn very high frequency driver. Operates with the Royal 400 in two- or three-channel stereophonic systems.

Audiophile Net \$69.50

Electro-Voice®

ELECTRO-VOICE, INC. / BUCHANAN, MICHIGAN

Printed in U.S.A.